



Model: PACE-X Powerhouse	Mar. 3, 2020
Serial #: PH1133 through PH1153	
Product Bulletin # PDC-018 v 1.0	

Ethylene Glycol Charging Procedure for VFD Cooling

Scope

This procedure describes the process for Ethylene Glycol charging for the Variable Frequency Drive (VFD) cooling system. This document applies to PACE-X Powerhouse starting at S/N: PH1133 and ending with S/N: PH1153.

This document is intended for the following purposes:

- New-build Powerhouse upon first construction
- After repairs that have introduced air into the system
- After repairs where significant fluid loss has taken place

This procedure can be undertaken by someone with a general knowledge of VFD operation. This procedure should take approximately 1-1/2 hours to complete.

List of Tools Needed

- PPE Identified in related MSD sheets
- 50 ft. 1/2" clear plastic hoses (drainage tubes)
- 10 ft. 1" garden hose
- Flashlight for sighting pump direction
- 30 gallons of ethylene glycol
- 5 gallon clean tub for catching fluid overflow
- Socket wrench set
- Duct tape
- Hose clamps
- Digital multi-meter
- Inductive ammeter
- Thermocouple
- Rubber plugs
- Tie-wraps



Model: PACE-X Powerhouse

Serial #: PH1133 through
PH1153

Mar. 3, 2020

Preparation

1. Create a J.S.A. for all possible hazards that would apply. In particular, ensure personnel is wearing appropriate PPE when coming into contact with the Ethylene Glycol mixture. Reference MSDS sheet for the product. This product is toxic, wash hands frequently to avoid any contamination. Ensure adequate ventilation before attempting this procedure.
2. Clean all catch buckets and supply fluid tanks to prevent introducing contaminants into the cooling system.
3. Ensure that a 600VAC MCC is available for powering the VFD cooling pumps.
4. Ensure that a 208VAC source is available for powering the immersion heater.
5. Lockout/tagout (LOTO) all electrical power.



Warning: Wait 5 to 10 minutes before starting the job to ensure there is no residual capacitive charge present in the VFD.

6. With power off, verify that the immersion heater is turned on. The heater knob is in full clockwise position (250°F) as shown in Figure 1a and Figure 1b.



Figure 1a: Immersion heater

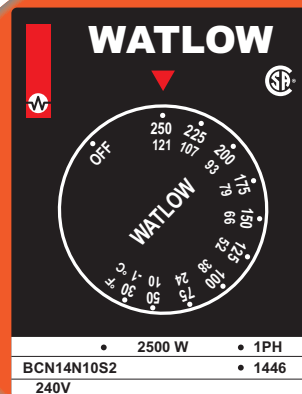
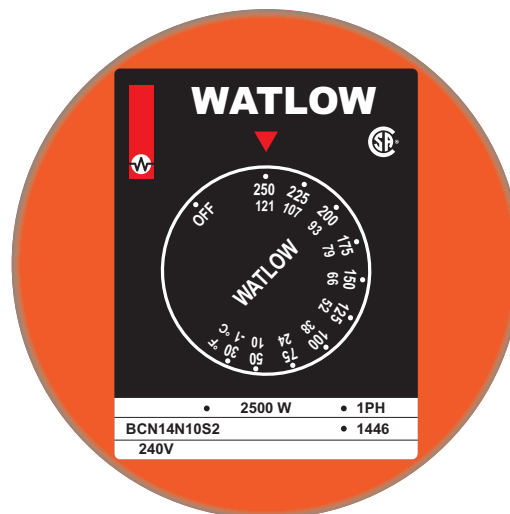

Figure 1b: Heater knob top view

- Take a digital multi-meter with thermocouple and tape end to one of the vertical 2-inch copper suction side riser. Ensure thermocouple is securely touching the copper as shown in Figure 2. Alternatively an infrared thermometer may be used.



Place thermocouple in this area

Figure 2: Thermocouple placement

- Ensure that the 3/4 inch ball valve at the expansion tank is in the open position. Use a standard tire pressure gauge to verify that the expansion tank has 40 PSI factory charge. Add air if required. See Figure 3.

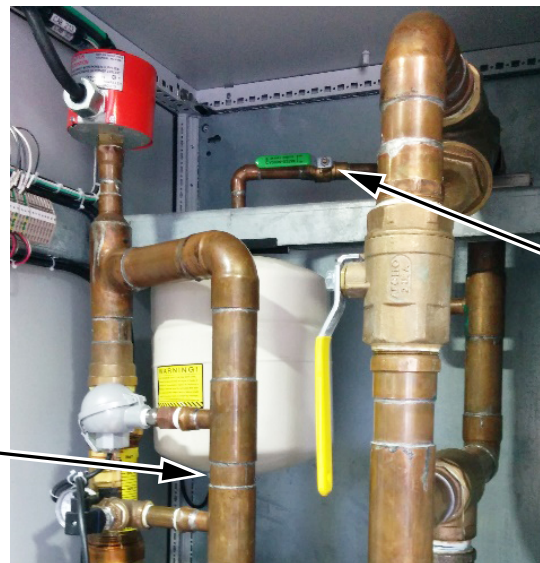

Ball valve open

Charge port on expansion tank

Figure 3: Expansion Tank

9. Ensure that ball valve at inlet of strainer is in the open position and the 3-way valve directs fluid through the strainer. See Figure 4.

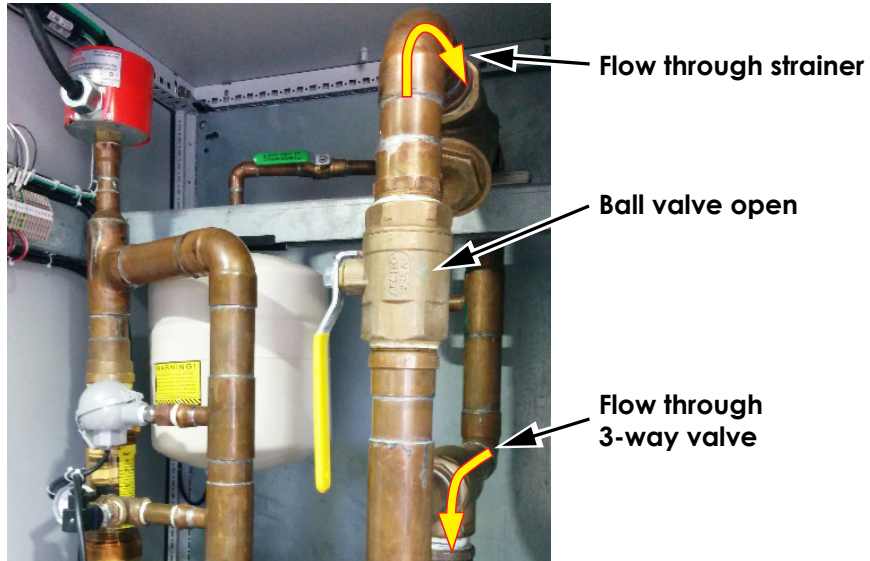

Figure 4: Ball valve open

10. Ensure that all ball valves on the suction and supply side of the pump are in the open position. See Figure 5.

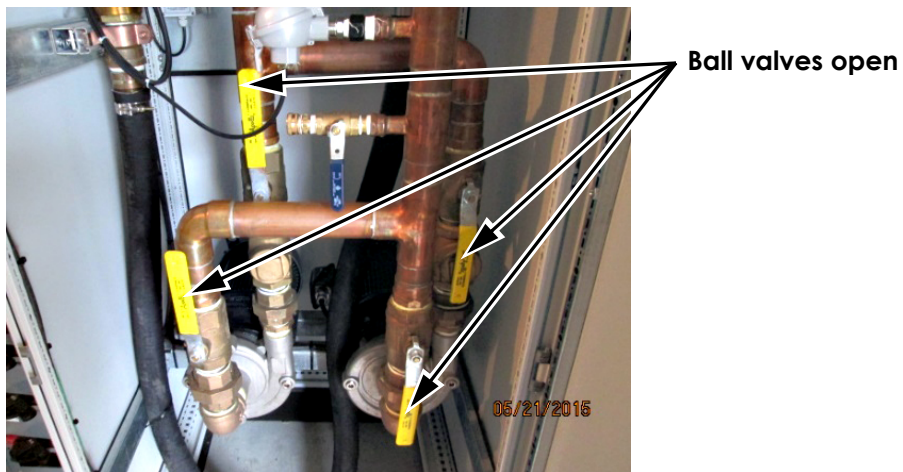

Figure 5: Suction and supply ball valves open

11. Ensure that the drain valve is closed. See Figure 6.

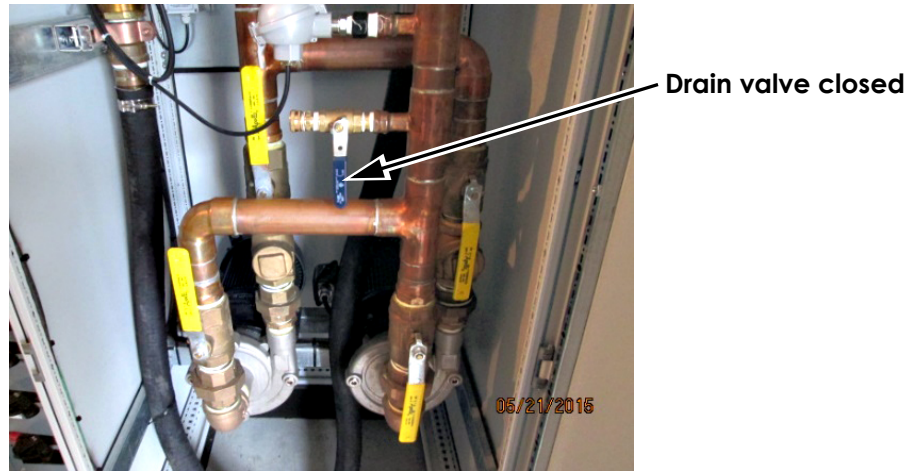

Figure 6: Drain valve closed

12. Connect a clear bleed hose to the air vent valve on each drive and secure with a hose clamp. Open each air vent valve. See Figure 7.

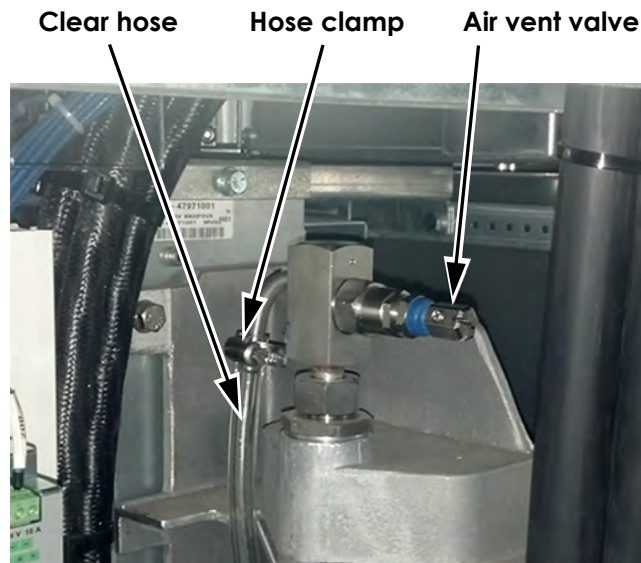

Figure 7: Air vent valve

13. Ensure that all the bleed hoses from the drives are connected together and routed back to the supply tank. See Figure 8 and Figure 9.



Figure 8: Connect bleed hoses together

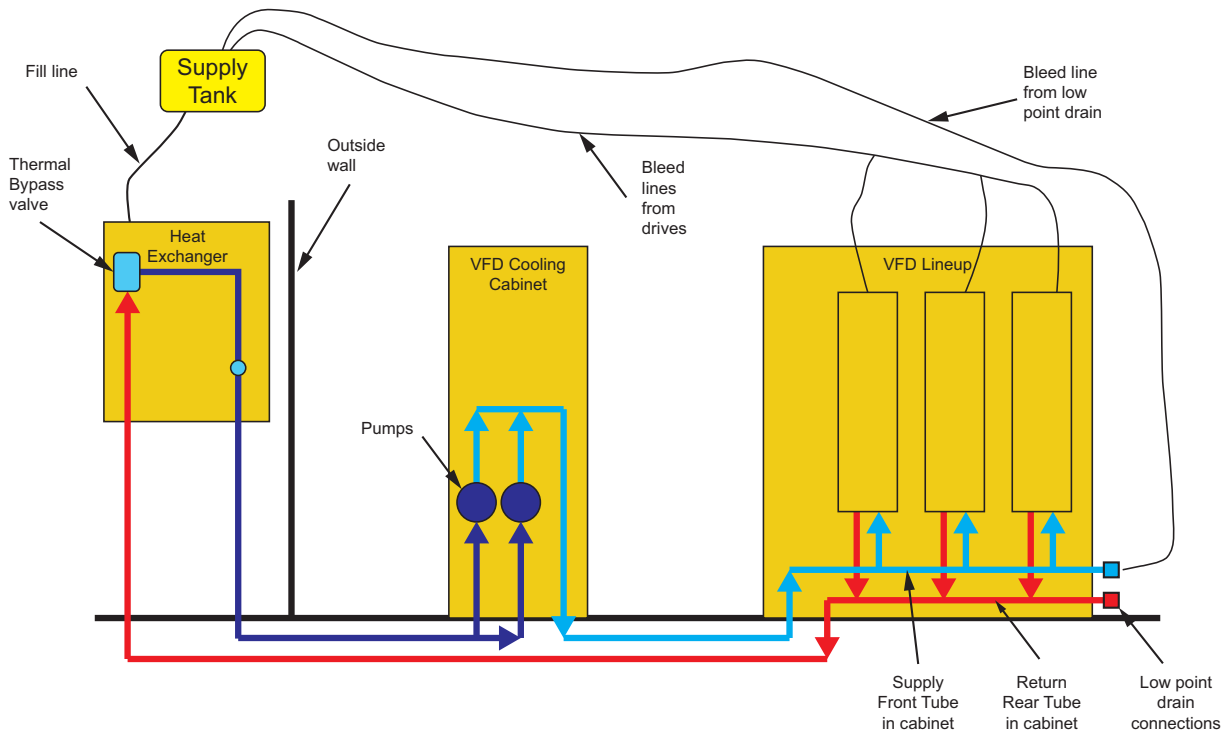

Figure 9: Simplified VFD cooling system diagram

Model: PACE-X Powerhouse	Mar. 3, 2020
Serial #: PH1133 through PH1153	
PH1153	

14. Ensure that the ball valve in the return line at the low point drain connection is closed. (The return line is the furthest rearward position in the cabinet.) Connect a transparent tube to the low point drain connection of the supply line. The supply line is the most forward connection in the cabinet. See Figure 10.



Note: The entire length of tube does not have to be transparent. A short transparent section to allow observation of the fluid will be sufficient.

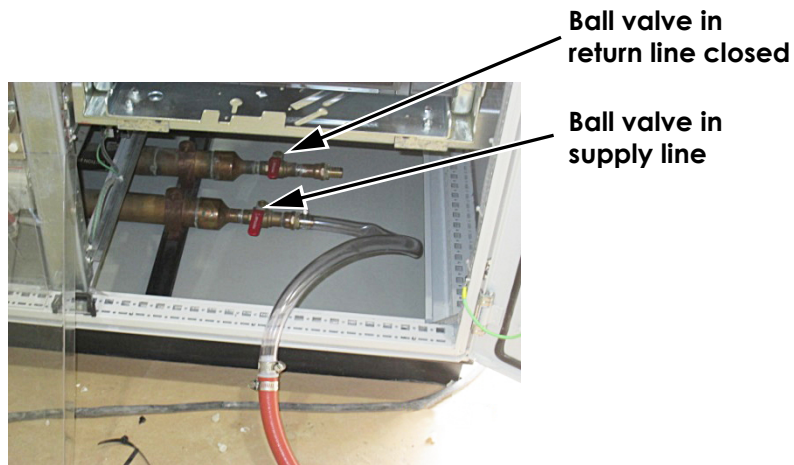

Figure 10: The supply line is the most forward connection in the VFD lineup

15. Route the supply line back to the supply tank. Stabilize the end of the hose with zip ties to keep pressure from blowing it out of the tank and then open the ball valve at low point drain connection of the supply line. See Figure 9 on page 6 and Figure 10 above.

Model: PACE-X Powerhouse	Mar. 3, 2020
Serial #: PH1133 through PH1153	

16. Ensure the input ball valve at the heat exchanger riser is in the closed position and connect the fill line input from the supply tank to the 2" NPT union connection at the heat exchanger riser. See Figure 9 on page 6 and Figure 11.

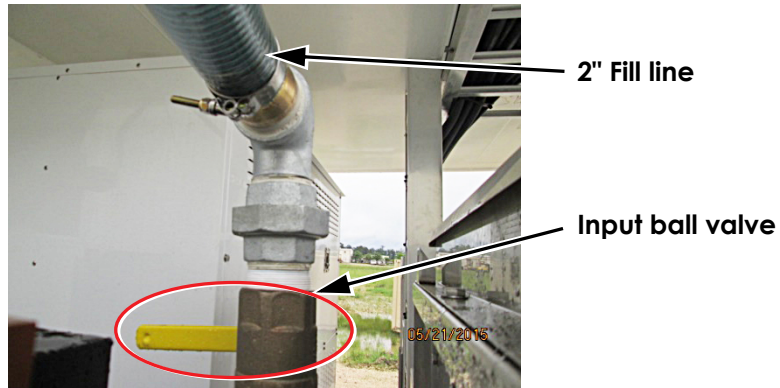

Figure 11: Input ball valve closed

17. Mark the fluid level of the supply tank and verify that at least 50 gallons of WEG is available before starting the charging procedure. Verify that all fill and bleed lines enter the supply tank above the fluid level and are secured to the supply tank to prevent them from blowing out during the charging procedure. This will prevent return flow from causing fluid in the supply tank to be agitated or foamy in appearance and expedite deaeration. Open the supply tank ball valve. See Figure 9 on page 6 and Figure 12.

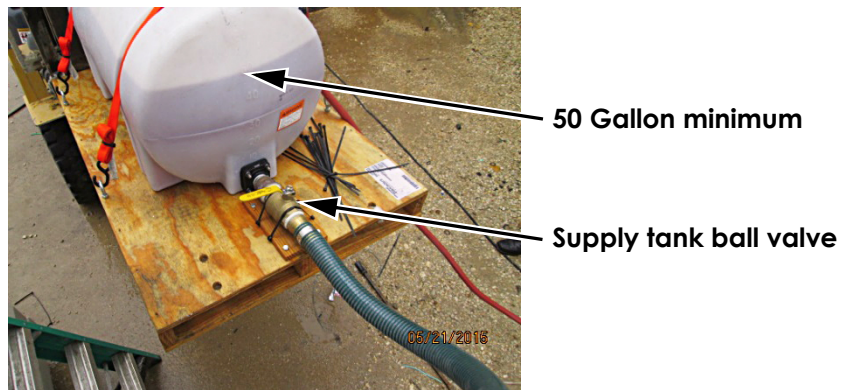

Figure 12: Supply tank level

Model: PACE-X Powerhouse	Mar. 3, 2020
Serial #: PH1133 through PH1153	
PH1153	

18. Raise the supply tank with a forklift and place on a suitable stand, taking care that the fill line and bleed lines are not snagged or kinked in the process. See Figure 9 on page 6 and 13.

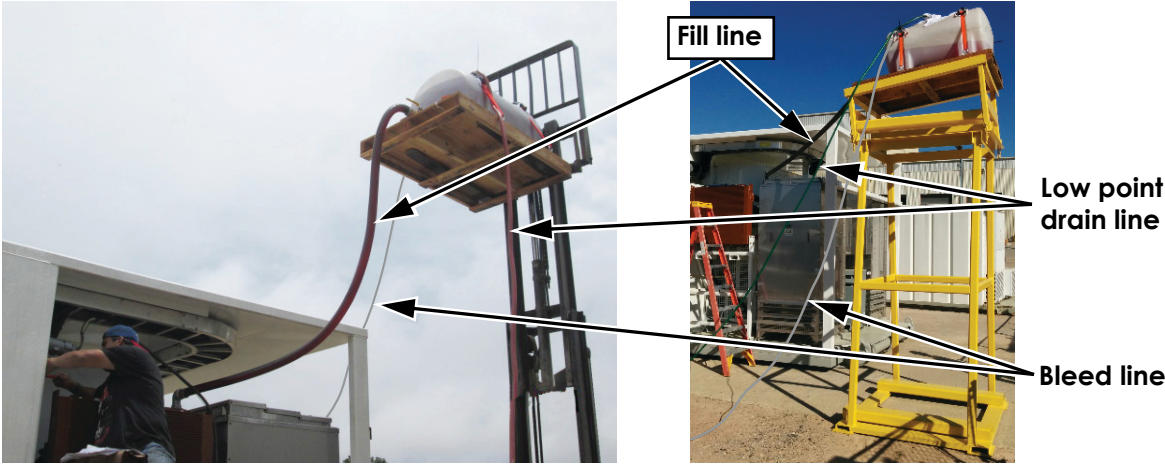

Figure 13: Supply tank on stand

19. Record the start time and open the input ball valve to allow the flow of fluid from the supply tank into the system. See Figure 12 on page 8. The charging procedure should take about one hour from start to finish. The gravity feed of the fluid will happen fast. You will hear air escaping and then fluid will be present at the air vent valves on the Convertteam drives. At this time close the air vent valves on the drives. See Figure 7 on page 5.

20. Notify all personnel that 600VAC power will be introduced to pumps and 208VAC to the immersion heater. Lockout/tagout (LOTO) all other equipment and wait 5 to 10 minutes to ensure that there is no residual capacitive charge present in the VFD.

21. With an assistant watching pump 1 through an inspection window in the back of the housing, start and stop pump 1 quickly and visibly verify proper rotation as shown in Figure 14.

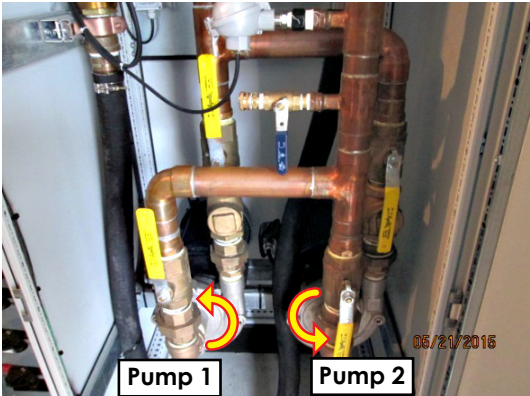

Figure 14: Rotation should be anti-clockwise as viewed from the outside of the cabinet



Model: PACE-X Powerhouse

Serial #: PH1133 through
PH1153

Mar. 3, 2020

22. With an assistant watching pump 2 through an inspection window in the back of the housing, start and stop pump 2 quickly and visibly verify proper rotation as shown in Figure 14 on page 9.
23. If either pump is running backwards, lockout the VFD and have an electrician correct lead wiring.
24. Start pump 1 and run for 30 seconds.
25. Turn off pump 1. Initiate pump 2 and run for 30 seconds.
26. Verify that fluid flow between 60 and 70 GPM is present in the flow meter sight tube. See Figure 15.



Figure 15: Flow meter

27. Repeat this process three (3) times and then leave either pump on for duration of task.
28. Starting at one end of the drive lineup, open the first bleed line. An opaque, frothy liquid will flow out and turn more transparent after a few seconds. At that point, close the bleed line. Systematically repeat for each of the drives to the end of the line. See Figure 7 on page 5.

Model: PACE-X Powerhouse	Mar. 3, 2020
Serial #: PH1133 through PH1153	
PH1153	

29. Turn on power for the immersion heater and use an inductive ammeter to measure the Amp draw. A reading of 8 Amp is anticipated to ensure correct operation. Refer to Figure 16.



Warning! Take care not to touch the pipes in the area immediately surrounding the immersion heater as the surface might be extremely hot and could cause a burn wound. See Figure 17.

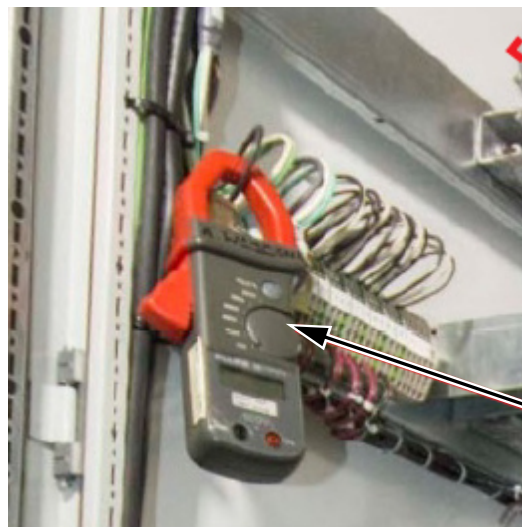

Inductive Ammeter

Figure 16: Inductive Ammeter

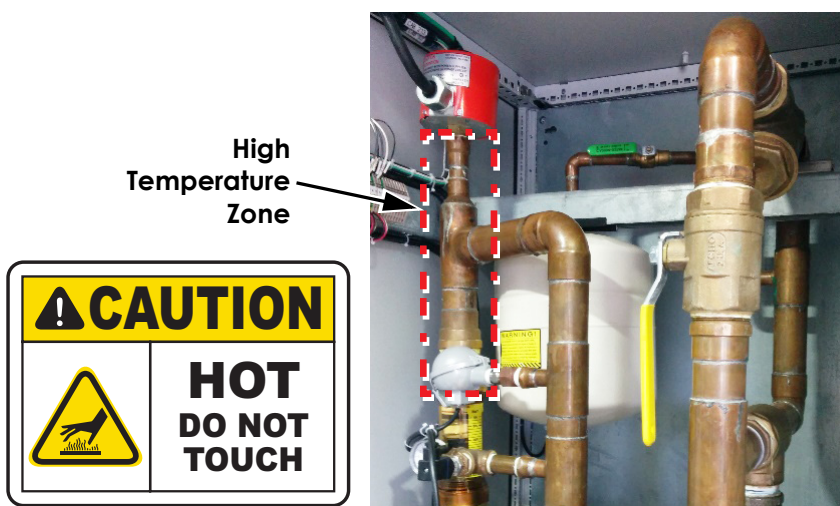

High Temperature Zone

Figure 17: High Temperature Zone



Model: PACE-X Powerhouse	Mar. 3, 2020
Serial #: PH1133 through PH1153	

30. Monitor the fluid temperature on the thermocouple. (see Figure 2 on page 3). At 75°F, the thermal bypass valve on the heat exchanger will open and direct the fluid flow through the heat exchanger.
31. Systematically bleed all Converteam drives as in Step 28 on page 10. Start at one end and open valves to expel foamy fluid and air pockets for constant flow. Close the valve and move to the next.
32. Repeat bleeding of all Converteam drives until the fluid color turns from opaque (see Figure 18a) to translucent (see Figure 18b).

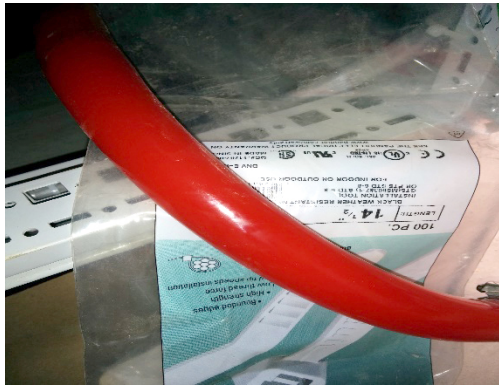

Figure 18a: Opaque fluid

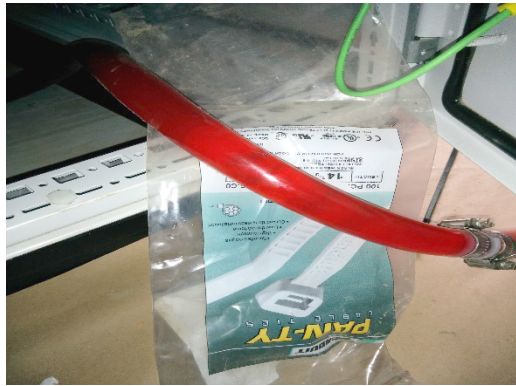

Figure 18b: Translucent fluid

33. Once a translucent fluid is observed throughout the entire circuit, close the low point drain connection (see Figure 10 on page 7) and then fill connection ball valve (see Figure 11 on page 8).

34. Turn pump off and start again with 5 second delay to ensure flow gauge does not stick in place and that 60 to 70 GPM flow is recorded. See Figure 19.

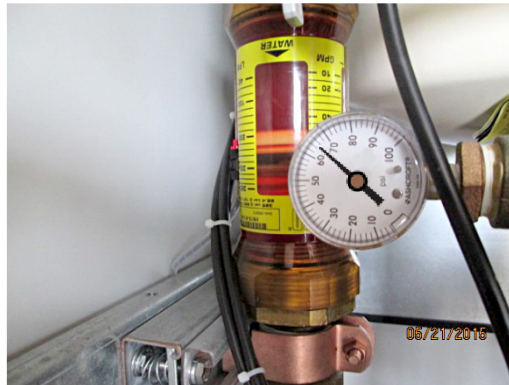

Figure 19: Flow gauge reading 60 to 70 GPM

35. Check that pipe temperature is @ 85°F or above. See Figure 2 on page 3.



Note: The thermal bypass valve opens at 75°F to direct fluid through the heat exchanger. Under extremely low ambient conditions the fluid temperature might not reach 85 °F and the thermal bypass valve test cannot be completed. Skip to Step 38.

36. Turn on heat exchanger fan and ensure it blows in an outward direction across the coils. With the heat exchanger running, the 85°F pipe temperature will drop with approximately 10°F in one minute. This will verify that fluid is flowing correctly through the thermal bypass valve and heat exchanger.
37. Turn heat exchanger fan off.
38. Turn immersion heater off at lighting breaker panel supply. The heater knob remains in the full on position. See Figure 1b on page 2.
39. Turn pump off.
40. Turn main 600VAC and 208VAC feeds off and lock-out.
41. Lower supply tank to ground level, taking care not to snag the fill or vent lines.
42. Remove all drain and supply hoses and cap inputs and output.



Model: PACE-X Powerhouse	Mar. 3, 2020
Serial #: PH1133 through PH1153	

43. Remove all Converteam drive and rectifier bleed hoses from the common drain hose. Remove any residual fluid and plug with rubber plugs supplied. Tie wrap neatly in cabinet away from bussing and circuitry.
44. Ensure all possible fluid drips are wiped away clean.
45. Account for all tools used and make sure all safety covers are installed.
46. Be sure to collect all fluid in hoses and return to main supply tank. Compare the final fluid level in the supply tank against the initial fluid level and validate that about 29 gallons was used in the charging of the system.
47. Notify test department or integrator that unit is fully charged and ready for operation.